

FILS, TÊTES, LAMES PIÈCES ET ACCESSOIRES DÉBROUSSAILLEUSES ET TAILLE-HAIES



Accessoires pour renvoi d'angle	233	Fil nylon carré Titanium	222
Accessoires pour taille-haies	238	Fil nylon hélicoïdal	221
Adaptateur pour renvoi d'angle universel	233	Fil nylon Nylsaw	221
Adaptateur pour têtes.....	226 - 227	Fil nylon rond blanc	220
Brosses de désherbage	228	Fil nylon rond Titanium	222
Coffret de 120 écrous.....	234	Fil Techni-Blade™	224
Couteaux débroussailleuses Nylon	228	Fil Ouragan	223
Coupe fils nylon	228	Lames de débroussailleuses	235 - 237
Cylindres-pistons pour débroussailleuses Stihl	232	Lames pour taille-haies	238
Écrous et vis pour débroussailleuses.....	234	Pièces détachées pour tête Tecomec et Oregon.....	227
Fil Duoline™	224	Protecteurs de débroussailleuses	234
Fil Flexiblade	224	Renvois d'angle	232 - 233
Fil GreenTek.....	220	Renvois d'angle universel.....	233
Fil Nylium carré.....	223	Tableau d'Adaptation des têtes à Fil Nylon.....	229
Fil Nylium étoilé.....	223	Têtes débroussailleuses.....	225 - 226
Fil nylon carré orange	220		

FIL NYLON ROND BLANC - UNE MARQUE SODIPIÈCES

Fabriqué avec des matières à haute durabilité. Excellente résistance à l'abrasion. Moins de casse à l'œillet. Coupe plus nette. Fil Nylon fabriqué en France.



Code	Ø (mm)	Longueur	Code	Ø (mm)	Longueur	Code	Ø (mm)	Longueur
09150	1,2	Coque de 15 m	09052	2,4	Coque de 90 m	09047	3	Bobine de 120 m
09151	1,6	Coque de 15 m	09154	3	Coque de 9 m	09048	3,3	Bobine de 90 m
09140	1,6	Coque de 100 m	09143	3	Coque de 30 m	09081	4	Bobine de 90m
09152	2	Coque de 15 m	09053	3	Coque de 60 m	23425	2	Grande bobine de 503 m
09141	2	Coque de 65 m	09049	3,3	Coque de 45 m	23426	3	Grande bobine de 620 m
09153	2,4	Coque de 15 m	09046	2,4	Bobine de 180 m			
09142	2,4	Coque de 45 m						

FIL NYLON CARRÉ ORANGE - UNE MARQUE SODIPIÈCES

Fabriqué avec des matières à haute durabilité. Excellente résistance à l'abrasion. Moins de casse à l'œillet. Coupe plus nette. Fil Nylon fabriqué en France.



Code	Ø (mm)	Longueur	Code	Ø (mm)	Longueur	Code	Ø (mm)	Longueur
09613	2,4	Coque de 15 m	09619	4	Coque de 9 m	09621	4	Bobine de 50 m
09614	2,4	Coque de 69 m	09620	4	Coque de 25 m	09637	4	Bobine de 120 m
09616	3	Coque de 12 m	09615	2,4	Bobine de 136 m	09638	4,5	Bobine de 98 m
09617	3	Coque de 44 m	09618	3	Bobine de 88 m	09634	2,4	75 brins de 42 cm
						09635	3	50 brins de 42 cm
						09636	4	26 brins de 42 cm

FIL GREENTEK



Code	Ø (mm)	Longueur	Code	Ø (mm)	Longueur	Code	Ø (mm)	Longueur
09400	1,6	Cavalier de 15 m	09404	2,4	Cavalier de 15 m.	09408	3	Coque de 55 m
09401	2	Cavalier de 15 m	09405	2,7	Cavalier de 15 m.	09409	2,4	Coque de 72 m.
09402	2,4	Cavalier de 15 m	09406	3	Cavalier de 15 m	09410	2,7	Coque de 58 m
09403	3	Cavalier de 15 m	09407	2,4	Coque de 86 m	09411	3	Coque de 46 m



FIL NYLON CUTER'PRO HÉLICOÏDAL - UNE MARQUE SODIPIÈCES

Le fil pour débroussailleuse Cuter Pro® est un fil hélicoïdal bi-composant... Cuter Pro® est un torsadé bi-couleur, fabriqué par le n°1 mondial qui est Français. Fils débroussailleuses pour particuliers et professionnels. La nouvelle forme hélicoïdale Cuter Pro® offre de nombreux avantages : réduction des bruits de coupe. Les déchets couleurs noir/vert sont facilement intégrables à la nature. Le composant bi-matière de Cuter Pro® allie dureté et résistance.



Code	Ø (mm)	Longueur	Code	Ø (mm)	Longueur	Code	Ø (mm)	Longueur
 22400	2,4	Coque de 15 m	 22405	3,3	Coque de 23 m	 43035	2,4	Bobine de 960 m
 22403	2,4	Coque de 43 m	 22408	3,3	Coque de 46 m	 22410	3	Bobine de 168 m
 22406	2,4	Coque de 86 m	 22421	4	Coque de 17 m	 22413	3	Bobine de 279 m
 22401	3	Coque de 15 m	 22422	4	Coque de 34 m	 22411	3,3	Bobine de 139 m
 22404	3	Coque de 28 m	 22409	2,4	Bobine de 262 m	 22414	3,3	Bobine de 231 m
 22407	3	Coque de 55 m	 22412	2,4	Bobine de 437 m	 22423	4	Bobine de 92 m
 22402	3,3	Coque de 15 m				 22424	4	Bobine de 168 m

FIL NYLON NYLSAW

Fabriqué avec des matières à haute durabilité. Excellente résistance à l'abrasion. Moins de casse à l'œillet. Coupe plus nette. Fil Nylon fabriqué en France.



Code	Ø (en mm)	Longueur	Nbre brins	Code	Ø (en mm)	Longueur	Nbre brins
 18554	3	Coque de 37 m		 18560	4	Bobine de 74 m	
 18555	3,5	Coque de 27 m		 18561	4,5	Bobine de 58 m	
 18556	4	Coque de 21 m		 18550	3	0,26 m	35
 18557	4,5	Coque de 16 m		 18551	3,5	0,26 m	25
 18558	3	Bobine de 132 m		 18552	4	0,26 m	20
 18559	3,5	Bobine de 97 m		 18553	4,5	0,26 m	15



Un service client à votre écoute



Consultez nos stocks en temps réel



Des remises toute l'année

FIL NYLON ROND TITANIUM

Titanium power est un nouveau mono filament qui combine deux matériaux aux caractéristiques techniques révolutionnaires. Un cœur dur qui réduit les cassures, recouvert d'une peau extrêmement résistante aux entailles et à l'usure. Le fil mono filament rond ou carré ! Le fil Titanium Power® est fabriqué en France.



Code	Ø (en mm)	Longueur	Code	Ø (en mm)	Longueur	Code	Ø (en mm)	Longueur
 21400	2,5	Coque de 15 m	 21404	3	Coque de 28 m	 21408	3,5	Coque de 41 m
 21403	2,5	Coque de 40 m	 21407	3	Coque de 56 m	 21409	2,5	Bobine de 243 m
 21406	2,5	Coque de 81 m	 21402	3,5	Coque de 9 m	 21410	3	Bobine de 169 m
 21401	3	Coque de 15 m	 21405	3,5	Coque de 21 m	 21411	3,5	Bobine de 124 m

FIL NYLON CARRÉ TITANIUM

Titanium power est un nouveau mono filament qui combine deux matériaux aux caractéristiques techniques révolutionnaires. Un cœur dur qui réduit les cassures, recouvert d'une peau extrêmement résistante aux entailles et à l'usure. Le fil mono filament rond ou carré ! Le fil Titanium Power® est fabriqué en France.



Code	Ø (en mm)	Longueur	Code	Ø (en mm)	Longueur	Code	Ø (en mm)	Longueur
 21412	2,5	Coque de 15 m	 21419	3	Coque de 44 m	 21478	4	Bobine titanium carré de 4 x 72 m
 21415	2,5	Coque de 32 m	 21414	3,5	Coque de 6 m	 21479	4	Bobine titanium carré de 4 x 121 m
 21418	2,5	Coque de 64 m	 21417	3,5	Coque de 16 m	 21421	2,5	Bobine de 191 m
 21413	3	Coque de 9 m	 21420	3,5	Coque de 32 m	 21422	3	Bobine de 132 m
 21416	3	Coque de 22 m	 21477	4	Coque titanium carré de 4 x 23 m	 21423	3,5	Bobine de 97 m

Fil Nylon



FIL OURAGAN - UNE MARQUE SODIPIÈCES

Ouragan pour une utilisation intensive, convient pour tous les types de végétation, du gazon aux mauvaises herbes épaisses et sèches ! La gamme Ouragan est composée de l'un des mélanges exclusifs les plus durables. Ce mélange exclusif absorbe les chocs, résiste à l'usure et réduit la casse des œillets lorsque vous travaillez contre des clôtures, des chaussées et des sols pierreux.



Code	Ø (en mm)	Longueur	Code	Ø (en mm)	Longueur	Code	Ø (en mm)	Longueur			
	22430	2,4	Fil 2,4 mm x 72 m Spirale Blister		22434	4	Fil 4 mm x 26 m Spirale Blister		22438	2,7	Fil 2,7 mm x 286 m Spirale Bobine
	22431	2,7	Fil 2,7 mm x 59 m Spirale Blister		22435	3	Fil 3 mm x 144 m Spirale Bobine		22439	3	Fil 3 mm x 238 m Spirale Bobine
	22432	3	Fil 3 mm x 50 m Spirale Blister		22436	3,3	Fil 3,3 mm x 128 m Spirale Bobine		22440	4	Fil 4 mm x 120 m Spirale Bobine
	22433	3,3	Fil 3,3 mm x 46 m Spirale Blister		22437	4	Fil 4 mm x 70 m Spirale Bobine				

FIL NYLIUM CARRÉ

D'une résistance hors norme, Nylium est probablement le fil le plus solide du marché. Nylium est vendu ici, dans sa forme carrée. Nylium se place dans la catégorie de fil dit : professionnel. Nylium en bobine contient de nombreuses et fines particules d'aluminium. Le mélange de l'aluminium au copolyamide Oregon réduit très fortement la casse à l'œillet. Nylium abaisse aussi, le point de fusion du fil dans la tête tout en maintenant une performance de coupe maximum. Oregon est le leader mondial en chaînes, guides, accessoires forestier et jardinage. Oregon Nylium est fabriqué en France.













Code	Ø (en mm)	Longueur	Code	Ø (en mm)	Longueur	Code	Ø (en mm)	Longueur			
	80428	2,4	Coque de 60 m		80431	4	Coque de 22 m		80426	2,55	Tube 100 brins 26 cm
	80429	3	Coque de 40 m		80433	3	Bobine de 155 m		80427	3,75	Tube 50 brins 26 cm
	80430	3,5	Coque de 30 m		80434	3,75	Bobine de 100 m				

FIL NYLIUM ÉTOILÉ

Nylium, de Oregon, le seul fil du marché, doté de composants aluminium. D'une résistance hors norme, Nylium est probablement le fil le plus solide du marché. Nylium est vendu ici, dans sa forme étoilée à 5 branches. Nylium se place dans la catégorie de fil dit : professionnel. Nylium starline en bobine contient de nombreuses et fines particules d'aluminium. Le mélange de l'aluminium au copolyamide Oregon réduit très fortement la casse à l'œillet. Nylium starline abaisse aussi, le point de fusion du fil dans la tête tout en maintenant une performance de coupe maximum. Oregon est le leader mondial en chaînes, guides, accessoires forestier et jardinage. Oregon Nylium Starline est fabriqué en France.



Code	Ø (en mm)	Longueur	Code	Ø (en mm)	Longueur	Code	Ø (en mm)	Longueur			
	80416	1,3	Coque de 15 m		80420	2,4	Coque de 90 m		80423	2,4	Bobine de 360 m
	80417	1,6	Coque de 15 m		80421	2,7	Coque de 70 m		80424	3	Bobine de 240 m
	80418	2,4	Coque de 15 m		80422	3	Coque de 60 m		80425	3,3	Bobine de 200 m
	80419	3	Coque de 15 m								



Un service client à votre écoute



Consultez nos stocks en temps réel



Des remises toute l'année

FIL DUOLINE™

Duoline, l'un des fils débroussailluse, parmi les plus techniques de la marque Orégon. Un double composant transparent/noir au service de l'efficacité. Duoline est vendu dans sa forme ronde. Il existe en diamètre minimum de 2,4 mm, ce qui place ce fil dans la catégorie de fil dit : professionnel. Il est préconisé pour des débroussailluses d'une bonne puissance. Orégon est le leader mondial en chaînes, guides, accessoires forestier et jardinage. Le fil pour débroussailluse Duoline d'Orégon est fabriqué en France.



	Code	Ø (en mm)	Longueur		Code	Ø (en mm)	Longueur		Code	Ø (en mm)	Longueur
	80407	2,4	Coque de 15 m		80409	2,4	Coque de 90 m		80412	3,5	Coque de 40 m
	80408	3	Coque de 15 m		80410	2,7	Coque de 70 m		80413	3,4	Bobine de 180 m
	80487	4	Coque de 64 m		80411	3	Coque de 60 m		80414	2,7	Bobine de 140 m
									80415	3	Bobine de 120 m

FIL FLEXIBLADE

Sodipièces vous présente la gamme de fil débroussailluse Oregon Flexiblade® ! Le fil débroussailluse Oregon Flexiblade® révolutionne l'univers et la technologie dans le domaine des coupes bordures et des débroussailluses. La puissance de coupe extrême de Flexiblade® provient de son profil à bord d'attaque dentelé. Ces stries agissent comme les dents d'une scie et mettent de multiples surfaces de coupe en contact avec la végétation, lui permettant ainsi d'atteindre aisément des mauvaises herbes d'un diamètre de 20 mm. Flexiblade™ d'Orégon est silencieux et économique grâce à ses propriétés aérodynamiques. Rendement et longévité sont aussi 2 qualitatifs qui font de Flexiblade® un fil exceptionnel. Retrouvez dès à présent la gamme de brins coupés, de coques et de rouleaux Flexiblade® !



	Code	Ø (en mm)	Nombre de brins et Longueur		Code	Ø (en mm)	Nombre de brins et Longueur		Code	Ø (en mm)	Nombre de brins et Longueur
	80454	2,5	Coque de 53 m		80458	4	Coque de 21 m		80449	2,5	Tube de 50 brins
	80455	2,65	Coque de 47 m		80460	2,65	Bobine de 250 m		80451	3	Tube de 35 brins
	80456	3	Coque de 37 m		80461	3	Bobine de 195 m		80452	3,5	Tube de 25 brins
	80457	3,5	Coque de 27 m		80463	4	Bobine de 110 m				

FIL TECHNI-BLADE™



Techniblade, d'Orégon, c'est à coup sûr le produit qu'il vous faut pour tailler et couper vos herbes et broussailles ultra résistantes. Avec ses dents acérées et son revêtement extérieur de couleur, Techni-Blade offre une meilleure visibilité et une plus grande sécurité. Il est composé de matériaux polymère durci 6/66 haute qualité avec un point de fusion/rupture à plus de 255°. Plus sûr qu'une lame d'acier, pas de risque de rebond. Techni-Blade fait partie de ces produits hors norme, signé Orégon. Techni-Blade, fils débroussailluse en brins de 26 cm. Le fil Techni-Blade est vendu en brins pour votre tête débroussailluse. Techni-Blade de Orégon est fabriqué en France.



	Code	Ø (en mm)	Nombre de brins et longueur		Code	Ø (en mm)	Nombre de brins et longueur
	80435	7	40 brins de 26 cm		80437	5	70 brins de 26 cm
	80436	6	50 brins de 26 cm		80485	7	155 brins



TÊTES DÉBROUSSAILLEUSES

Code	Marque	Type		Ø tête en mm		Adaptation							Nombre de fils	Matière	Type de fil	Ø fil en mm	
		Tap' N'Go	Manuelle	20 et 25,4	Mâle 8 x 1,25 Pas à gauche	Femelle 8 x 1,25 Pas à gauche	Femelle 10 x 1,00 Pas à gauche	Femelle 10 x 1,25 Pas à gauche	Femelle 12 x 1,50 Pas à gauche	Femelle 12 x 1,75 Pas à gauche	Vendue sans adaptateurs						
 09181	ARNETOLI	X		123	X									2	Nylon	Rond	2,4
 23449	TECOMEC	X		130									X	2	Nylon	Tout	2,4 à 4
 23411	TECOMEC	X		130	X								X	2	Nylon	Tout	2,4 à 4
 23437	TECOMEC	X		130		X			X					2	Nylon	Tout	2,4 à 4
 23446	TECOMEC	X		130				X		X				2	Nylon	Tout	2,4 à 4
 23442	TECOMEC	X		130	X									2	Nylon	Tout	2,4 à 4
 23410	TECOMEC	X		109	X									2	Nylon	Tout	2 à 3,5
 23435	TECOMEC	X		130				X		X				2	Nylon	Tout	2,4 à 4
 23441	TECOMEC	X		109	X									2	Nylon	Tout	2 à 3,5
 23447	TECOMEC	X		109				X		X				2	Nylon	Tout	2 à 3,5
 23433	TECOMEC	X		130		X			X					2	Nylon	Tout	2 à 4
 80400	OREGON	X		109		X	X	X	X					2	Nylon	Tout	Jusqu'à 4
 80442	OREGON	X		130		X		X	X	X	X			2	Nylon	Tout	Jusqu'à 4
 23438	TECOMEC	X		130									X	2	Nylon	Tout	2,4 à 4
 23440	TECOMEC	X		160									X	2	Nylon	Tout	2,4 à 4
 09630	TECOMEC		X	60	X									6	Nylon	Tout	Jusqu'à 4
 09632	TECOMEC		X	80	X									8	Alu	Tout	Jusqu'à 4
 09631	TECOMEC		X	80	X									8	Alu/nylon	Tout	Jusqu'à 4



Nos produits d'atelier SharkOil



Un service client à votre écoute

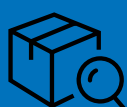















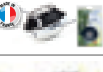



Consultez nos stocks en temps réel



Des remises toute l'année

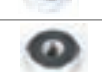











TÊTES DÉBROUSSAILLEUSES

Code	Marque	Type		Ø tête en mm	Adaptation									Nombre de fils	Matériau	Type de fil	Ø fil en mm	
		Tap N°Go	Manuelle		20 et 25,4	Mâle 8 x 1,25 Pas à gauche	Femelle 8 x 1,25 Pas à gauche	Femelle 10 x 1,00 Pas à gauche	Femelle 10 x 1,25 Pas à gauche	Femelle 12 x 1,50 Pas à gauche	Femelle 12 x 1,75 Pas à gauche	Vendue sans adaptateurs						
 09633	TECOMEK		X	80	X										2 x 8	Alu	Tout	Jusqu'à 4
 23448	TECOMEK		X	80	X										8	Alu/nylon	Tout	Jusqu'à 4
 18571	SPEED		X	100	X										4	Alu	Tout	1,6 à 5
 18570	SPEED		X	100	X										2	Alu	Tout	1,6 à 5
 80447	OREGON		X	100	X										2	Alu	Tout	Jusqu'à 4
 80448	OREGON		X	100	X										4	Alu	Tout	Jusqu'à 4
 80920	OREGON		X	123									X	2	Nylon	Rond et étoilé	Jusqu'à 3	
 22418	SPEED		X	109	X										2	Alu/nylon	Tout	2 à 3,5
 22419	SPEED		X	90	X										2	Alu/nylon	Tout	2 à 3
 26400	KALYSTA		X	45	X										2	Alu	Tout	2,4 à 4
 23612	GREENTEK	X		110	X										8	Alu	Carré	3 mm
 23613	GREENTEK	X		90				X	X	X	X				2	Nylon	Rond	2 mm
 23614	GREENTEK	X		120				X	X	X	X				2	Nylon	Rond	2,4 mm
 23615	GREENTEK	X		106					X						2	Nylon	Rond	2,4 mm
 23616	GREENTEK	X		106					X						2	Alu/Nylon	Rond	2,4 mm
 23617	GREENTEK	X		150					X						2	Nylon	Rond	2,4 mm
 23482	GREENTEK	X		130				X							2	Nylon	Rond	2,4 à 2,5 mm
 23483	GREENTEK	X		160						X					2	Nylon	Tout	2,4 à 3,3 mm
 23486	GREENTEK	X		145				X							2	Nylon	Tout	2,4 à 2,7 mm
 23487	GREENTEK	X		160				X							2	Nylon	Tout	2,4 à 3,3 mm











ADAPTATEURS POUR TÊTES

Code	Désignation	S'adapte sur nos têtes références												
		23449	23411	23437	23446	23442	23410	23435	23441	23447	23433	23438	23440	
 26511	M14 x 1,5 LH.F		X	X		X		X		X		X	X	X
 26502	M10 x 1,25 LH.F	X	X	X	X	X	X	X	X	X	X	X	X	X
 26509	M12 x 1,75 LH.F		X	X		X		X		X		X	X	X
 26529	M10 x 1,25 LH. M	X	X	X	X	X	X	X	X	X	X	X	X	X
 26530	M10 x 1,50 LH. M	X	X	X	X	X	X	X	X	X	X	X	X	X



Code	Désignation	S'adapte sur nos têtes références													
		23449	23411	23437	23446	23442	23410	23435	23441	23447	23433	23438	23440		
N	 26506	M8 x 1,25 LH. M	X	X	X	X	X	X	X	X	X	X	X	X	X
N	 26510	M10 x 1,5 LH. F	X	X	X	X	X	X	X	X	X	X	X	X	X
N	 26528	M10 x 1 LH. F	X	X	X	X	X	X	X	X	X	X	X	X	X
N	 26538	M10 x 1,25 LH. F	X	X	X	X	X	X	X	X	X	X	X	X	X
N	 26533	M12 x 1,5 LH. F	X	X	X	X	X	X	X	X	X	X	X	X	X
N	 26527	M8 x 1,25 LH. F	X	X	X	X	X	X	X	X	X	X	X	X	X
N	 26532	M12 x 1,25 LH. F	X	X	X	X	X	X	X	X	X	X	X	X	X
N	 26537	M8 x 1,25 LH. M	X	X	X	X	X	X	X	X	X	X	X	X	X
N	 26514	M12 x 1,25 LH. F	X	X	X	X	X		X		X	X	X	X	X
N	 26504	M12 x 1,5 LH. F		X	X		X		X			X	X	X	X
N	 26534	M12 x 1,50 LH. F	X	X	X	X	X	X	X	X	X	X	X	X	X
N	 26505	M8 x 1,25 LH. F	X	X	X	X	X	X	X	X	X	X	X	X	X

PIÈCES DÉTACHÉES POUR TÊTES TECOME ET OREGON

Code	Désignation	S'adapte sur nos têtes références																	
		09632	18570	18571	23449	23411	23437	23446	23442	23410	23435	23441	23447	23433	23438	23440	80400	80442	
N	 26501	Passe-fils de remplacement										X							
N	 26552	Kit de remplacement comprenant le couvercle inférieur et le bouton				X		X											
N	 26525	Kit de remplacement contenant la bague et le ressort				X		X											
N	 26544	Bobine de fil de remplacement					X												
N	 26519	Kit de remplacement contenant le couvercle inférieur et la bobine de fil					X												
N	 26539	Kit de remplacement comprenant le couvercle inférieur et le bouton										X							
N	 26558	Passe-fils de remplacement					X	X			X			X	X	X			
N	 23556	Passe-fils de remplacement				X		X				X							
N	 26500	Couvercle inférieur de remplacement							X										
N	 26540	Couvercle inférieur							X										



Un service client à votre écoute













Consultez nos stocks en temps réel



Des remises toute l'année

PIÈCES DÉTACHÉES

Code	Désignation	S'adapte sur nos têtes références																	
		09632	18570	18571	23449	23411	23437	23446	23442	23410	23435	23441	23447	23433	23438	23440	80400	80442	
 26541	Couvercle inférieur de remplacement												X						
 80478	Ressort de remplacement																X		
 80479	Bobine intérieur de remplacement																		X
 80480	Ressort de remplacement																		X
 24425	Ecrou acier	X																	
 24426	Rondelles	X																	
 23420	Kit 2 taquets goupille + 2 ressorts pour tête débroussailleuse alu 2 fils		X																
 23421	Kit 4 vis 5 x 12		X																
 23423	Kit 6 rondelles métalliques		X	X															
 23424	Bol, talon		X																
 23422	Kit 4 vis 5 x 22			X															

COUPE FILS

Code	Désignation
 21465	Coupe fil nylon pour fils débroussailleuse. À l'unité

COUTEAUX DÉBROUSSAILLEUSES NYLON

Code	Désignation	Code	Désignation
 09037	Disque débroussailleuse 3 couteaux nylon escamotables. Ø de coupe : 260 mm. Alésage : 25,4 mm		 09651 Lame 6 dents étoilé en acier. Spécial taillis.. Ø 245 mm. Al 25,4 mm. Ep 1,6 mm.
 09038	Jeu de 3 couteaux nylon pour notre tête 09037		

BROSSES DE DÉSHÉRBAGE





Code	Désignation	Code	Désignation
 29500	Brosse rilsan universelle, corps en polypropylène, avec rangées de tresses Rilsan. Hauteur : 70 mm, Ø ext. : 160 mm, alésage : 20 ou 25,4 mm avec bague, Longueur des brins : 40 à 45 mm	 21448	Brosse conique pro pour le déshérbage. Ø : 200 mm, en utilisation la brosse s'étend sur 230 mm. Alésage : 25,4 mm
 21447	Brosse conique pro pour le déshérbage. Ø : 200 mm, en utilisation la brosse s'étend sur 230 mm. Alésage : 20 mm		 26913 Brosse conique de déshérbage à fils tressés petit modèle. Ø : 150 mm, alésage : 25,4 mm + bague de réduction à 12,5 mm et 10,3 mm



TABLEAU D'ADAPTATIONS DES TÊTES À FIL NYLON

Attention : la mention mâle ou femelle correspond à l'adaptateur de tête à fil nylon



Marque	Modèle	Mâle ou femelle	Diamètre	Pas de filetage	Gauche ou droite
ALKO	LT250C - BC250	M	8	125	G
ALKO	MS400 - 106146	F	10	125	G
ALKO	MS400 106389 - 106144 - 106436 - 106145	F	8	125	G
ALLEN	SDS20 - B719 - BT22	F	8	125	G
ALLEN	MINI23 - SUPER 22	M	7	100	G
ALLEN	MINI26 - PRO230 - PRO260	M	8	125	G
ALLEN	PRO34 - 342 - 37 - 43 - 435 - 534	M	10	125	G
ARIMITSU	ACC15 - ACC17 - ACD17 - ACD18 - ACE30 - ACEZK	M	8	125	G
ARIMITSU	AM16D - AM24 - AM24D - AM31 - AM31K - AM31KL	M	8	125	G
ARIMITSU	AM40 - AM50	M	8	125	G
ALPINA	170 - 180 - 190 - 200	M	8	125	G
ALPINA	VIP21 - VIP25 - VIP30 - VIP34 - VIR34D - VIR34F - VIR42	F	8	125	G
ALPINA	VIR35F - VIR52 - VIR52D - VIR52F - VIR42D - VIR42F	F	8	125	G
ALPINA	210 - 220	F	10	125	G
BLACK & DECKER	STRIMMER 17 CC	F	8	125	D
BLUE BIRD	SBC23E - 27E - NBC31EA - NBC38E - M47 - M54	F	10	100	G
THE BLUES & WOODLORD	BR161DM - BC231DM - BC241DX	M	8	125	G
THE BLUES & WOODLORD	BT181 - BC181 - BC241	F	8	125	G
THE BLUES & WOODLORD	BC240 - BC350 - BC480 - BC500	M	10	125	G
THE BLUES & WOODLORD	BC330 - BC400	F	10	150	G
CHIC & WARRIOR	KD18 - KD24 - KD33 - KD40 - KD50 - SK18D	M	8	125	G
CHIC & WARRIOR	SU50V	F	10	100	G
CHIC & WARRIOR	SU40V	F	10	150	G
DANARM	WHIPPER MKIII	F	10	125	G
DANARM	TORNADO - WHIPPER MKII - 23 MKIII - 24E	F	8	125	G
DANARM	23 MKI - 23 MKII - 33	F	10	150	G
DANARM	WHIPPER MKI	F	8	100	D
DANARM	DANARM32 - 35 - 40 - 50	M	10	125	G
DOLMAR	BC250 - LT250 - BC330 - BC400 - SD330 - BC250	M	10	125	G
DOLMAR	PRO370 - PRO400 - MS3300/4000/4500	M	10	125	G
DOLMAR	BC337 - BC377 - NB26 - NB03 - NB04 - NB31 - NB40 - MS3500	F	10	100	G
DOLMAR	NB40 - NB411 - NB50 - NB351 - BD330 - C250 - LT250	F	10	100	G
DOLMAR	BC225 - C225 - LT225 - MS220 - MS2300 - MS2600 - MS3100	F	8	125	G
DOLMAR	LT154 - NB - NB01F - NB02 - NB16F - NB211 - NBF171	F	8	125	G
DOLMAR	NB26/31 - LT225 - LT255 - NB2 - NB271 - MS250 - MS3200	F	8	125	G
DOLMAR	M5200 - MS2810 - MS340 - BC12 - BC210 - BC212	F	10	125	G
DOLMAR	MS5250 - BC210 - BC212 - MS30C - MS30U	F	10	125	G
DOLMAR	MS3300 - MS4000 - MS4500 - MS3310 - MS4010 - MS4510	F	12	150	G
DOLMAR	NB231AU - NB231A - NB23F - NB171 - LT250	F	8	125	D
DOLMAR	LT210	F	10	125	D
ECHO	TOUS MODÈLES	F	10	125	G
ECHO	FCLS4600 - CLS5800 - CLS5810	F	12	175	G
EFCO	200 SÉRIES 200 - 2201C - 260/D - 2601C - 2601CVA - 261/A	M	8	125	G
EFCO	300 SÉRIES 300A/AIC - 301 - 310 - 350	M	8	125	G
EFCO	400 SÉRIES 400/AIC - 400A - 410 - 450 - 460/AVS	M	8	125	G

Marque	Modèle	Mâle ou femelle	Diamètre	Pas de filetage	Gauche ou droite
EFCO	8060 - 8100 - 8200 - 8250R - STARK26TR	F	8	125	G
EFCO	8250RL - 8220IC - 8260IC - STARK261C - 8250/IC/ICD - 8300NEW	M	8	125	G
EFCO	8250ICD - 8250ICNEW - 8350/IC - 8400/IC - 8460/IC - 8530/IC	M	8	125	G
EFCO	8550BOSS - 8355 - 8405 - 8465 - 8535	M	8	125	G
FLYMO	MULTI TRIM	F	10	100	G
FLYMO	D2	F	8	125	G
FLYMO	MAXI TRIM SUPER	F	3/8	24	D
FORESTAL	F30 - F40	M	8	125	G
FUJI-ROBIN	NB16F - NB211 - NB02	F	8	125	G
FUJI-ROBIN	NB03 - NB04	F	10	100	G
GOLDEN STAR	ALL MODES KFBG40DX - KFS2G18L - KFS4G18	M	8	125	G
GOLDEN STAR	KFS4EG2D - KFS4G24 - KFBGG33	M	8	125	G
GREEN MACHINE	1200 - 1500 - 1600 - 1700 - 1900 - 2000 - 2100 - 2200 - 2331	M	8	125	G
GREEN MACHINE	2340 - 2500/LP - 3000/LP - 3451	M	8	125	G
GREEN MACHINE	4500LP	F	10	125	G
GREEN MACHINE	4500 - 4000 - 4000/LP	M	10	125	G
HATSUTA	HB27 - HB23	M	10	125	G
HOMELITE	TM523	M	7	100	G
HOMELITE	BCH20 - 24 2D - 32C - 33 - 33B - 33DI - 33TO	M	8	125	G
HOMELITE	HBC30 - 30B - 38 - 40 - HK14 - 18 - 24 - 28 - 33 - 38	F	8	125	G
HOMELITE	PBC3600 - 3600E - PLT3400 - ST155 - 175C - 185C - 285C - 385C	F	8	125	G
HOMELITE	ST485 - ST485C	F	8	125	G
HOMELITE	ST20 - ST40 - ST60 - ST100 - ST200 - ST360 - ST385 - 400	M	8	125	G
HOMELITE	SXD20 - TK518 - NBA524 - PMB522 - TXD508 - RK521	M	8	125	G
HOMELITE	BCH38 - BCH40 - BCH48 - PBC3800 - PBC400	F	10	125	G
HOMELITE	NBA524 - PMB522 - TXD508 - SXD40 - FK514	M	10	125	G
HOMELITE	ST160 - 180 - 200 - 210	F	3/8	24	G
HONDA	UH41 - SDX25HE	M	8	125	G
HONDA	UMK422LTE/UT4E/LT4E	F	10	125	G
HUSQVARNA	24R AVANT 1987	M	7	100	G
HUSQVARNA	265RX - 250RX - 245RX - 132R - 132RD - 132LD - 125R - 25R	F	12	175	G
HUSQVARNA	125RD - 125LD - 125RB - 132RL - 245R - 125L - 132L	F	12	175	G
HUSQVARNA	125RJ - 125RJD - 26R - 235R - 32L - 120L - 225L - 225LD - 227R	F	12	175	G
HUSQVARNA	232L - 232LCAT - 32R - 225RJ - 225R - RD - 232R - 232RCAT	F	10	125	G
HUSQVARNA	322L - 325LX/XT - 325RJX - 322RJ - 325RX/RXT	F	10	125	G
HUSQVARNA	H27GTS	F	10	150	G
HUSQVARNA	235RCAT - 240R - 240RBD - 250RX - 245R - 245RX - 265RX	F	12	175	G
HUSQVARNA	140R - 165R - 244 - 244R - 244GX - 36R - 39R - 16R - 18RL - 22RL	F	12	175	G
HUSQVARNA	240RJ - 142RB - 152RB - 252RX	F	12	175	G
HUSQVARNA	MONDO MEGA - MONDO MAXI	F	3/8	24	G
HUSQVARNA	26L	F	3/8	24	D
HUSQVARNA	16R - 25R AVANT 1987	M	8	125	G
IKRA	BT1045	M	8	125	G
IRINO	LA17 - S5 - SH17	M	8	125	G
IRINO	LB20 - LB24	F	10	100	G
ISEKI/SHINDAIWA	DYB190 - DYB191	M	3/8	24	D
ISEKI/SHINDAIWA	DYB251 - DYB252 - DYB254 - DYB261 - DYB262	M	8	125	G
ISEKI/SHINDAIWA	DYB321 - DYB322	M	8	125	G



Un service client à votre écoute



Consultez nos stocks en temps réel



Des remises toute l'année

ADAPTATEURS POUR TÊTES

Marque	Modèle	Mâle ou femelle	Diamètre	Pas de filetage	Gauche ou droite
ISEKI/SHINDAIWA	DYB351 - DYB453 - DTB354 - DYB454	M	10	125	G
ISEKI/SHINDAIWA	DYB201 - DYB202 - DYB231 - DYB232	M	7	100	G
ISEKI/SHINDAIWA	IC12 - ICD13 - IC15 - IC16 - IC17 - IC18 - ICD13 - K16 - K17 - K18	F	9	125	G
ISEKI/SHINDAIWA	IAX180 - 190 - 250 - 350 - 400 - 500	F	8	125	G
JONSERED	G25RD	F	8	125	G
JONSERED	300 - 400 - LR200/B/L - LR260B/L	M	8	125	G
JONSERED	BP40COMBI - BR400/450 - GR26COMBI - GR26D/L - GR32L/CAT	F	10	125	G
JONSERED	GR44 - GT21/22/24 - RS44 - BP2040C - GR3032D/L	F	10	125	G
JONSERED	GR2026D/L/L - GT26D/L	F	10	125	G
JONSERED	J40D - KQ30 - KQ30NE - KOP20 - KQ20 - K20 - KQ - QLQ	F	10	125	G
JONSERED	GR32D/CAT - GR36/CAT - GR41/50 - R38/45 - RS30/38/40/45	F	12	175	G
JONSERED	RS51PRO - RS52 - GR2036 - BP2052 - BP240C	F	12	175	G
JONSERED	G25RD	F	8	125	G
KAZ	V20	M	7	100	G
KAZ	K10 - K20 - K2020 - K2Q - K2Q20 - K30 - KQ30 - KLQ - KOP20B - KPQ/20	F	8	125	G
KAZ	KQ - KQP20 - KQT130 - KT12 - RQ20 - U10 - V15/18/25 - 25VP15/20	F	8	125	G
KAZ	/230/250 - VX230/260	F	8	125	G
KAZ	KQ20 - V10	F	8	125	D
KAZ	410 - J40/BD/HD - J400/GX - JLKT200 - JLQT200 - JQ/40/50	F	10	125	G
KAZ	JQG4K - JGT200 - K40D/BD - KQ30/NE - KT10/18/1S/30	F	10	125	G
KAZ	KW30NE - RQ30/40 - RX350/351L - RX501 - T170/240/410 - V190/35/40 - V501	F	10	125	G
KAZ	V420/520 - VNX540 - VRX360/440/540 - VX221/251C/360/360S	F	10	125	G
KAZ	VX440	F	10	125	G
KOMATSU ZENOAH	BC220DL - BC221DL - BC17 - BC23 - BC32	M	7	100	G
KOMATSU ZENOAH	BC2300DL	F	8	100	G
KOMATSU ZENOAH	BC254A - BC260DM/DUM - BC260DM - BC340DWM/FW	M	8	125	G
KOMATSU ZENOAH	BC341DWH - BC431DWM - BC432FWM - BCD20 - BCF01	M	8	125	G
KOMATSU ZENOAH	BK345FL - BK435FL - BK530DL	M	8	125	G
KOMATSU ZENOAH	BC431FWM - BC531DWM - BC532DWM - BK531DL	M	10	125	G
KOMATSU ZENOAH	FBC22 - FBC26	M	10	125	G
KUBOTA	D200(23CC) - DS300(31CC)	F	8	125	G
KUBOTA	D100(17CC)	F	10	125	G
LAWNFLITE/TONDU	S100 - S1800	M	6	100	G
LAWNFLITE/TONDU	P7559-PRO250/255/256/262/330/3300/332/356/850/851 - S256	M	8	125	G
LAWNFLITE/TONDU	PRO852/8520 - PRO952/9520 - LAWNFLITE	M	10	150	G
LAWNKING	MODÈLES LK2D - 25 - 35 - 40	M	8	125	G
MC CULLOCH	BP30AV - DELTA - MS33/40 - S'MA-C30AV - 38AV - TD2400/3300/4000	M	8	125	G
MC CULLOCH	MAC22/23/30/38	F	8	125	G
MC CULLOCH	MAC17/25	F	8	125	D
MC CULLOCH	100A - 90A - 95A - 99A - EB3 - MAC80/90/95A - PS1/2/3/4/5	F	10	125	G
MC CULLOCH	SEB4 - SM100 - SMAC30AV - SMA-V38AV	F	10	125	G
MC CULLOCH	TD2100 - MAC32 - MAC37	M	10	125	G
MC CULLOCH	MAC60A - MAC80A	F	10	125	D
MC CULLOCH	SURPERMAC26 - MAC30A - 30AV - PRATER30	F	10	125	D
MC CULLOCH	EUROPA92/35A - EUROPA - MS24 - MS52	M	10	150	G
MC CULLOCH	PROMAC38AV - BP38AV - WIND-SORKIT26	M	10	150	G
MC CULLOCH	VERSAILLES38 - BP26AV - BP35AV	M	10	150	G
MC CULLOCH	MAC85A - MAC90A - MAC95A	F	10	125	G
MC CULLOCH	SMAC30AV - SMAC38AV	F	10	125	G

Marque	Modèle	Mâle ou femelle	Diamètre	Pas de filetage	Gauche ou droite
MC CULLOCH	60 - 60A - 70 - 80 - 95 - EB2	F	3/8	24	D
MAKITA	RBC230 - RBC260 - RBC310 - RBC410 - RBK410 - RBC525	M	8	125	G
MAKITA	DBC3300 - DBC4000 - DBC4000 - DBC4000C	F	12	150	G
MARUNAKA	BC180/181DX - BC200/240DX - TM2/21/24DX/F3L	F	8	125	G
MARUNAKA	BT181DX	F	8	125	D
MARUNAKA	G8K - G13K	F	10	125	G
MARUNAKA	BC480DX - G3/5 - GL3K - T240DX/F53/L	M	10	125	G
MARUNAKA	TM33DX/F43L - TM33DX/F43 - T200DX/F43L	F	10	150	G
MARUNAKA	T200DX/F43 - TM33JX/F404L - T200JX/F404L	F	10	150	G
MARUNAKA	BC330DX - BC400DX - BK404FX	F	10	150	G
MARUYAMA	BC184/C - BC220DE - BC230/241/326/330/402/480	M	8	125	G
MARUYAMA	BC331BK-MB100/250/300/400/500	M	8	125	G
MARUYAMA	32 - 35	M	10	125	G
MARUYAMA	23	F	10	150	G
MARUYAMA	BC200C - BC260/H - MC260/S	F	10	125	G
MOUNTFLIED	16 - 18 - 22 - 23 - 24 - 26 - 33 - 40 - 43	M	8	125	G
MOUNTFLIED	33	M	10	100	G
MOUNTFLIED	31 - 37	M	10	125	G
NIKKARI	22 - 24 - 37 - SXD20 - RK521 - TKD518	M	8	125	G
NIKKARI	38 - PNB522 - TXD50B - NBA524 - SXD40 - KF514	M	10	125	G
OLEOMAC	TR60E - TR101E - 720 - SPAR-TA26TR - 725B	F	8	125	G
OLEOMAC	725BL - 722/726S - SPARTA26S - SPARTA26 - 725S/T/D - 730S/T	M	8	125	G
OLEOMAC	735S/T - 740S/T - 746S/T - 753S/T - 755MASTER	M	8	125	G
OLEOMAC	435/440/446/453BP	M	8	125	G
PAICE SETTER	K20 - KQ - KLQ - JQ	F	8	125	G
PAICE SETTER	J40D - KQ30	F	10	125	G
PAICE SETTER	J9	F	10	100	G
PARTNER	B400	F	10	100	G
PARTNER	200 - 203 - 205 - B250C - B250V avant 1987 - T250	F	10	125	G
PARTNER	B323 - B325	F	10	125	G
PARTNER	B370 - B380 - B180 - B440 - B450 - B405 - B250CV - B250U	F	12	175	G
PARTNER	B450G - B450C - B265J - B405	F	12	175	G
PARTNER	T221 - T321 - B322	F	8	100	G
PIONEER	S33 - S41 - S51	F	10	125	G
PIONEER	F16 - S16 - S24 - SF24	F	8	125	G
POULAN	150 - 200 - 2620 - 800 - 900	F	10	150	G
POULAN	770-PPC22/25/25E/31-PROSÉRIES 111 - 112 - 113 - 115 - 55	F	3/8	24	G
POULAN	PRO SÉRIES 609 - 1350 - 1500 - 2400 - 2500 - 2600 - 10/15 - 2700	F	3/8	24	G
POULAN	PRO114/7 - YARDPRO SÉRIES 115 - 120A - 130A - 145 - 160 - 20	F	3/8	24	G
POULAN	PRO MODELS 165 - 175 - 185 - 195 - 200 - 800 - 900 - 2620 - 2820	F	3/8	24	G
RED MAX	BC260/1/2DL - BC340/1/2DL - BC2200E/LDC	M	8	125	G
RED MAX	BC2300DL - BC2301S - BC2600DL - BC3400DL - BC4400DL	M	8	125	G
RED MAX	BCX2600/DL/S - BCZ2500S - BT2200LDC - G2KC - SGC2300DL	M	8	125	G
RED MAX	BC430DWM - BC440/1/2DWM	M	10	125	G
RED MAX	BC220DL - BC221DL - BC240DL - BC300DL	M	7	100	G
RED MAX	BT17 - BT220	F	8	125	G
ROBIN	NB30K - NBR30/40	M	8	125	G
ROBIN	IVBK411 - NB02 - NB16F - NB211 - NB26 - NB281A - NB31/AU	F	8	125	G
ROBIN	NB351 - NBA231 - NBK411 - NBT415 - IVBF231 - NB231	F	8	125	G
ROBIN	NB23F - NBF171 - NBF231	F	8	125	G
ROBIN	IVB50L - NB03/4 - NB411L - NB50L	F	10	100	G



RDV sur sodipieces.fr



Commandé avant 16h
livré le lendemain



04 77 53 44 91

Marque	Modèle	Mâle ou femelle	Diamètre	Pas de filetage	Gauche ou droite
RYOBI	180KS/S - 3318 - REK285BP	M	8	125	G
RYOBI	RD1605 - RD2414 - RD3818	F	8	125	G
RYOBI	RD5224 - RD5225 - RSB2801 - RSH1100	M	10	125	G
RYOBI	RD260	F	10	150	G
RYOBI	RD330 - RD430 - RD520	F	12	175	G
SHIKUTANI	122	F	8	125	G
SHIKUTANI	L155 - L183 - L185	F	10	150	G
SHIKUTANI	LK350	F	10	100	G
SHINDAIWA	C20/230 - LT18/20 - T18/20/A - T230/ XR - T23E - T35	M	7	100	G
SHINDAIWA	BP35/45 - C23/27 - C250 - T/27/250	F	8	125	G
SHINDAIWA	T260/270/350 - YARDWARE220	F	8	125	G
SHINDAIWA	F20 - R20 - R25 - R35F - C25 - T25	M	8	125	G
SHINDAIWA	B35/40/45 - BP35 - C35 - RC35/45 - F18	M	10	125	G
SHINGU	S100	M	6	100	G
SHINGU	M16	M	6	100	D
SHINGU	G1823DE/E - G2523DE/E - PG3330DD - PK2325E/DE	M	8	125	G
SHINGU	PK4035DD - PK4845DD - S20	M	8	125	G
SHINGU	PH4846DD - PK4036DD	M	10	150	G
SHINGUSHOKO	200 - 250 - 350 - K301	M	7	100	G
SHINGUSHOKO	600 - 650 - P700 - P750 - P850	M	8	125	G
STIHL	FS50 - FS50EL - FS51 - FS51AVEL - FS60 - FS61 - FS65 - FS80 - FS80E - FS90 - FS90AVE	M	8	125	G
STIHL	FS44 - FS52 - FS56 - FS66 - FS86 - FR106 - FS74 - FS74R	F	10	100	G
STIHL	FE55 - FS36 - FS88 - FR108 - FS40 - FS76 - FS76R	F	10	100	G
STIHL	FS106 - FS108 - FS48 - FS62 - FS81 - FS96	F	10	100	G
STIHL	FS160 - FS220 - FS55/R - FS25-4/R - FS65-4/R - FS80R - FS85/R/R	F	10	150	G
STIHL	420 - FS08 - FS150/160/180 - FS20 - FS200 - FS200AVSE - FS220FS280/K - FS 353 - FS353AV - FS36	F	12	150	G
STIHL	FS410 - FS 410AVE - FS420 - FR350/450 - FS350/450/400K/450K	F	12	150	G
STIHL	FS400/L - FS500 - FS550	F	12	150	G
SOLO	FS125 - S200 - S300	F	8	125	G
SOLO	123 - 125 - MULTIMAT	F	10	100	G
SOLO	124 - 126 - 127 - 128 - 130 - 134 - 140 - 137 - 140 - 141	F	12	150	G
TAS TANAKA	AST250/5000/7000 - SUM250 /301/321/321E/351/400	F	8	125	G

Marque	Modèle	Mâle ou femelle	Diamètre	Pas de filetage	Gauche ou droite
TAS TANAKA	SUM421/500/7000-TBC16/160/162/202/205/215/220/2200	F	8	125	G
TAS TANAKA	TBC225/255 - TCB23/232/250/250D H/262/265/265SDH/262	F	8	125	G
TAS TANAKA	TBC265/265SDH/30/300/322/355/37/373/400/422/422BDH	F	8	125	G
TAS TANAKA	TBC4500/500/5000/500DH/501/202	F	8	125	G
TAS TANAKA	TCB300SDH/355DH - TST218 - TUM220 - TUM250	F	8	125	G
TAS TANAKA	SUM3	F	10	125	G
TAS TANAKA	TBC16 - AST5000 - TBC5000 - TBC4000	F	8	125	D
TONDU	LAWNFLITE	M	10	125	G
TONDU	M16 - M18	M	6	100	D
TONDU	S100 - S180	M	6	100	G
TONDU	S200 - S250 - S255 - 260 - 350	M	7	100	G
TONDU	PRO250/256/262/330/332 - PRO850/851 - S256 - PRO255	M	8	125	G
TONDU	PRO852 - PRO952	M	10	150	G
TORO	TC2100/3000/4000/5000 - TC600/650/700/800	F	10	125	G
TORO	"P" RANGE	M	8	125	G
WARRIOR	BT161M - BC181DX - BC231DM - BC241DX - BC330DX - BC331FX	M	8	125	G
WEED EATER	22 - 82 - 848 - 599	M	8	125	G
WEED EATER	PRO37	M	10	125	G
WEED EATER	1000 - 609 - PRO195 - XR90/95/100 - XR105 - XR125 - XR200	F	10	150	G
WEED EATER	XR90 - XR95 - YP140 - YP160 - YP200	F	10	150	G
WEED EATER	1400 - 1500 - 1600 - 1700 - 3500 - 559 - 599 - 600 - 607	F	3/8	24	D
WEED EATER	GT115/117/118 - XR20/30/50/70/80/85 - XT20/50/85	F	3/8	24	D
WEED EATER	YP110/120/130	F	3/8	24	D
WESTMAC	16	F	8	100	D
WESTMAC	19S - 33S - W180/190/240/245/330	F	8	125	G
WESTMAC	23 - 31	M	8	125	G
WESTMAC	35 - 40 - 50 - 68	F	10	100	G
WESTMAC	W40	F	10	125	G
WESTMAC	RS40/45	F	12	175	G
YAMAHA	YBC20D - YBC30D - YBC40D	M	8	125	G
YAMAHA	YBC50D	M	10	125	G
ZENOAH	BC17 - BC23 - BC32 - BC220	M	7	100	G
ZENOAH	BCF01 - BCD20 - BC260	M	8	125	G
ZENOAH	FBC26 - FBC22	M	10	125	G



Un service client à votre écoute



Consultez nos stocks en temps réel







Des remises toute l'année

CYLINDRES-PISTONS POUR DÉBROUSSAILLEUSE STIHL

	Code	Remplace N° Origine	Désignation
	71078	STIHL N°4119 020 1203, 4119 020 1205	Cylindre piston pour FS160, FS180. Ø 35 mm
	71079	STIHL N°4119 020 1204	Cylindre piston pour FS160, FS180, FS220, FS280, FS290, FR220, FS220K, FS280K Attention il existe différents montages. Ø 38 mm
	71058	STIHL N°4134 020 1212, 4119 020 1204, 4134 020 1210, 1114 020 1200	Cylindre piston pour FS120, FS180, FS200, FS250, FS202, FS350, FR350. Attention il existe différents montages. Ø 38 mm
	71057	STIHL N°4134 020 1213	Cylindre piston pour FS120. Ø 35 mm
	71050	STIHL N°4128 020 1211	Cylindre piston pour FR350, FR450, FS400, FS450, SP450, SP451. Attention il existe différents montages. Ø 42 mm
	71052	STIHL N°4119 020 1216, 4119 020 1202	Cylindre piston pour FS280. Ø 40 mm
	71051	STIHL N°4128 020 1202	Cylindre piston pour FS480, FR450. Ø 44 mm
	71049	STIHL N°4128 020 1201	Cylindre piston pour FS400, FS400-K, FS400-L, FS450, FS480, SP400, SP450. Attention il existe différents montages. Ø 40 mm
	71075	STIHL N°4116 020 1215	Cylindre piston pour FS360, FS420, FS420L, FS500, FS550, FS550L. Ø 46 mm

RENOIS D'ANGLE

	Code	Ø tube (en mm)	Ø arbre (en mm)	Entrainement	Désignation
	16457	28	8	9 cannelures	Pour tête universelle ou tête filetage femelle : 10 x 1,25
	16458	28	10	10 cannelures	Pour tête universelle ou tête filetage femelle : 10 x 1,25. Alésage pour lame de 25,4 mm
	16459	28	10	11 cannelures	Pour tête universelle ou tête filetage femelle : 10 x 1,25
	23452	28		Carré 6 x 6	Fixation tête débroussailleuse en M12 X 1,50. Remplace origine 4128-640-0101. 4128-641-0360A. Pour modèles FS160, FS180, FS220*
	16454	26		Carré 5,3	Pour tête universelle ou tête filetage femelle : 10 x 1,25

*Plus d'informations sur le site



















	Code	Ø tube (en mm)	Ø arbre (en mm)	Entrainement	Désignation
	16455	26	7,8	7 cannelures	Pour tête universelle ou tête filetage femelle : 10 x 1,25
	16456	26	8	9 cannelures	Pour tête universelle ou tête filetage femelle : 10 x 1,25
	23030	26	7	7 dents	Pas de vis : 10 x 1,25 gauche
	23031	26	7	9 dents	Pas de vis : 10 x 1,25 gauche
	23032	26		Carré 5 x 5	Pour tête universelle ou tête filetage femelle : 10 x 1,25
	23945	25		Carré 5 x 5	Axe de fixation des lames : 10 x 1,00 pas à gauche, écrou : 19 mm. Remplace origine Stihl n° 4137-640-0100. Pour modèles FS80*

RENOI D'ANGLE UNIVERSEL

Code	Désignation
 18500	Renvoi d'angle universel pour débroussailleuse jusqu'à 45 cm ³ . 5 adaptateurs pour tube Ø : 24, 25, 25,4, 26, 27 mm. Pas de vis : 10 x 1,25. Ø : 25,4 mm

ADAPTATEUR POUR RENVOI D'ANGLE UNIVERSEL

Code	Ø arbre (en mm)	Entrainement	Code	Ø arbre (en mm)	Entrainement
 18501	7	7 dents 	 18505		Carré de 5,4 mm 
 18502	9	9 dents 	 18506		Carré de 6 mm 
 18503	8	10 dents 	 18507		Profil STIHL oval, 5 mm 
 18504		Carré de 5,2 mm 	 18515		Profil STIHL oval, 6,5 mm 

ACCESSOIRES POUR RENVOI D'ANGLE

Code	Désignation	Code	Désignation
 18509	Carter de protection grand modèle Ø ext 85 mm	 18512	Flasque d'appui inférieur 6 cannelures
 18510	Flasque d'appui supérieur 6 cannelures	 18513	Flasque d'appui inférieur 10 cannelures
 18511	Flasque d'appui supérieur 10 cannelures		

*Plus d'informations sur le site



Un service client à votre écoute









Consultez nos stocks en temps réel





Des remises toute l'année

PROTECTEURS DE DÉBROUSSAILLEUSES

Code	Désignation
 09031	Protecteur de débroussailleuse modèle nylon universel. Livré avec des adaptateurs de fixation Ø 24, 26, 28 mm. Tube : 23 à 29 mm, largeur : 160 mm, longueur : 280 mm, hauteur : 30 mm
 09034	Protecteur de débroussailleuse modèle nylon universel. Livré avec des adaptateurs de fixation. Tube : 23 à 28 mm, largeur : 280 mm, longueur : 340 mm, hauteur : 60 mm
 09601	Protecteur de débroussailleuse grand modèle métallique large avec bande caoutchouc réglable
 09605	Protecteur de débroussailleuse. Modèle métallique moyen. Pour tube de 24 à 28 mm
 26003	Protecteur de débroussailleuse avec coupe fil intégré. Moyen modèle. Pour tube de Ø 24, 26 et 28 mm Ø de coupe : 380 mm
 26004	Protecteur de débroussailleuse avec coupe fil intégré. Grand modèle. Pour tube de Ø 24, 26 et 28 mm Ø de coupe : 420 mm

ECROUS ET VIS POUR DÉBROUSSAILLEUSES « PAS » À GAUCHE

Code	Désignation	Code	Désignation
 09551	Écrou de serrage. Ø 8 x 1,25 Pas à gauche	 09558	Vis de serrage. Ø 6 x 1,00 Pas à gauche
09552	Écrou de serrage. Ø 9 x 1,25 Pas à gauche	09559	Vis de serrage. Ø 7 x 1,00 Pas à gauche
09553	Écrou de serrage. Ø 10 x 1,00 Pas à gauche	09560	Vis de serrage. Ø 8 x 1,25 Pas à gauche
09554	Écrou de serrage. Ø 10 x 1,50 Pas à gauche	09561	Vis de serrage. Ø 10 x 1,50 Pas à gauche
09555	Écrou de serrage. Ø 10 x 1,25 Pas à gauche	09562	Vis de serrage. Ø 10 x 1,25 Pas à gauche
09556	Écrou de serrage. Ø 12 x 1,50 Pas à gauche	09563	Vis de serrage. Ø 5/16 x 18 Pas à gauche
09557	Écrou de serrage. Ø 12 x 1,75 Pas à gauche		

COFFRET DE 120 ÉCROUS

Code	Désignation
 09629	Coffret de 120 écrous et vis pour débroussailleuse. Pas à gauche. 15 pièces de chaque modèle. Ecrous : 8 x 1,25, 10 x 1,00, 10 x 1,25, 10 x 1,50. Vis : 7 x 1,00, 8 x 1,25, 10 x 1,50, 10 x 1,25



UNE MARQUE SODIPIÈCES























OURAGAN

FIL DÉBROUSSAILLEUSE HAUTE PERFORMANCE





LAMES DE DÉBROUSSAILLEUSES

Code	Type de lame	Ø de coupe (en mm)									Alésage (en mm)		Epaisseur										
		200	225	230	250	255	280	300	320	350	20	25,4	1,3	1,5	1,6	1,8	2	2,5	3	3,5	4	4,2	
UTILISATION PROFESSIONNELLE																							
	09014	Droite			X							X						X					
	09028	Droite					X					X						X					
	09029	Droite							X			X						X					
	09012	3 dents			X							X					X						
	16468	3 dents					X					X					X						
	16469	3 dents					X					X					X						
	16470	4 dents			X							X					X						
	09018	10 dents			X							X					X						
	09019	10 dents			X							X					X						
	09008	3 dents				X						X						X					
	80438	3 dents				X						X						X					
	09007	3 dents				X						X						X					
	09001	3 dents						X				X						X					
	80439	3 dents						X				X						X					
	16465	3 dents						X				X										X	
	80489	3 dents						X				X										X	
	09009	3 dents						X				X						X					
	09003	3 dents								X	X											X	
	21444	3 dents								X	X											X	
	18011	Courbée en "S"							X		X										X		
	18012	Courbée en "S"							X		X										X		
	18013	Courbée en "S"							X		X											X	
	18014	Courbée en "S"							X		X											X	



Un service client à votre écoute



Consultez nos stocks en temps réel





Des remises toute l'année

LAMES DE DÉBROUSSAILLEUSES

Code	Type de lame	Ø de coupe (en mm)									Alésage (en mm)		Epaisseur											
		200	225	230	250	255	280	300	320	350	20	25,4	1,3	1,5	1,6	1,8	2	2,5	3	3,5	4	4,2		
SPECIALES BROYAGE																								
	09041	Droite spéciale ronces							X			X											X	
	80440	Droite spéciale ronces							X				X										X	
	09611	Droite spéciale ronces							X			X												X
	80441	Droite spéciale ronces							X				X											X
	09042	Droite spéciale ronces							X				X									X		
	09612	Droite spéciale ronces							X				X											X
	09626	3 dents spéciale ronces							X				X											X
	09627	3 dents spéciale ronces							X					X										X
	80490	3 dents spéciale ronces							X					X										X
CLASSIQUES																								
	09004	Droite					X						X		X									
	09010	3 dents					X						X			X								
	09005	4 dents			X								X		X									
	09006	4 dents				X							X		X									
	09015	8 dents			X								X		X									
	09016	8 dents				X							X		X									
	09020	Scie / 80 dents			X								X		X									
	09021	Scie / 80 dents				X							X		X									
	09025	3 dents nylon				X							X										X	
	09026	4 dents nylon				X							X										X	
AIRECUT (SUPER PRO)																								
	42020	3 dents étoile							X				X											X
	42021	3 dents étoile									X		X											X



Code	Type de lame	Ø de coupe (en mm)									Alésage (en mm)		Epaisseur										
		200	225	230	250	255	280	300	320	350	20	25,4	1,3	1,5	1,6	1,8	2	2,5	3	3,5	4	4,2	
LAMES À DENTS PROFIL GOUGES - USAGE INTENSIF - COUPE ARBUSTES, GENÊTS, BROUSSAILLES																							
	16471	Disque / 22 dents	X									X											
	16472	Disque / 22 dents	X										X										
	16473	Disque / 22 dents		X								X							X				
	16474	Disque / 22 dents		X									X						X				
LAMES À DENTS PROFIL GOUGES - USAGE INTENSIF - COUPE PETITS BOIS ET BROUSSAILLES																							
	16475	Disque / 22 dents	X									X							X				
	16476	Disque / 22 dents	X										X						X				
	16477	Disque / 22 dents		X								X								X			
	16478	Disque / 22 dents		X									X							X			
LAME CARBURE À POINTES TUNGSTÈNE AVEC AÉRATIONS DE STABILISATION - USAGE INTENSIF																							
	72305	Disque / 36 dents			X								X	X									
	72306	Disque / 36 dents			X								X	X									
	72307	Disque / 36 dents			X								X	X									



Un service client à votre écoute



Consultez nos stocks en temps réel



Des remises toute l'année

LAMES POUR TAILLE-HAIES

Code	L (mm)	Remplace N° Origine	Désignation
21435	635	ALPINA N°TS24 DOLMAR N°HT2256D EFCO N°HT326S, TS322, TS326 GREEN MACHINE N°HT2300 KAWASAKI N°KHD600A*	Lame supérieure double denture de taille-haie. S'utilise avec lame inférieure 21436
21436	652	ALPINA N°TS24 DOLMAR N°HT2256D EFCO N°HT326S, TS322, TS326 GREEN MACHINE N°HT2300 KAWASAKI N°KHD600A*	Lame intérieure double denture de taille-haie. S'utilise avec lame supérieure 21435
21437	784	EFCO N°TS335, TS355	Lame supérieure double denture pour taille-haie. S'utilise avec la lame inférieure 21438
21438	790	EFCO N°TS335, TS355	Lame intérieure double denture pour taille-haie. S'utilise avec la lame supérieure 21437
21432	450	METABO N°HS8345s	Jeu de lame complet de taille-haie pour METABO
21439	670	STIHL N°HS45	Lame bilatérale de taille-haie pour STIHL
21440	615	STIHL N°HL45, HL45, HL75, HL75K	Lame bilatérale de taille-haie pour STIHL
21441	820	STIHL N°HS45	Lame bilatérale de taille-haie pour STIHL
21442	733	STIHL N°HS60, HS61, HS75, HS80, HS85, HS242, HS246	Lame bilatérale de taille-haie pour STIHL

ACCESSOIRES POUR TAILLE-HAIES

Code	Remplace N° Origine	Désignation
 21427	FREUND N°7300643, 9018033	Pour modèles P55, P65 et P75
 21434	METABO N°34 340 493, 34 340 696	Contacteur pour modèles HS8140S-000, HS8140S-002, HS8144S-000, HS8144S-002, HS8155S-000, HS8155S-002, HS8165S-000, HS8165S-002*

Cuter Pro



*Plus d'informations sur le site

